





15A-L070

A. $\varnothing 8 \times 30 \times 4$ 	B. $\varnothing 6 \times 18 \times 8$ 	C. $\varnothing 6 \times 40 \times 8$ 
D. $\varnothing 6 \times 1.5 \times 8$ 	E. $\varnothing 4 \times 60 \times 1$ 	



① x1

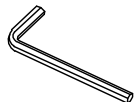
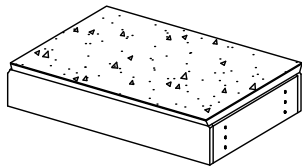
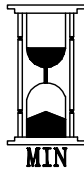
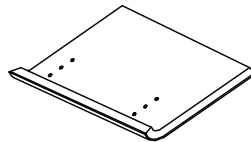

② x2

1

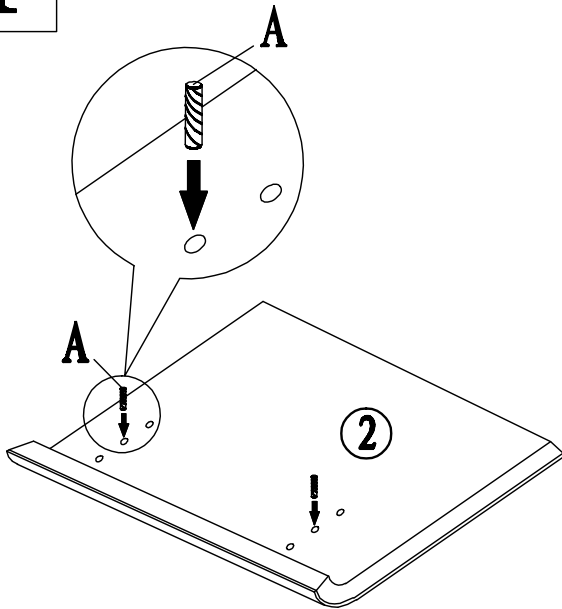

2

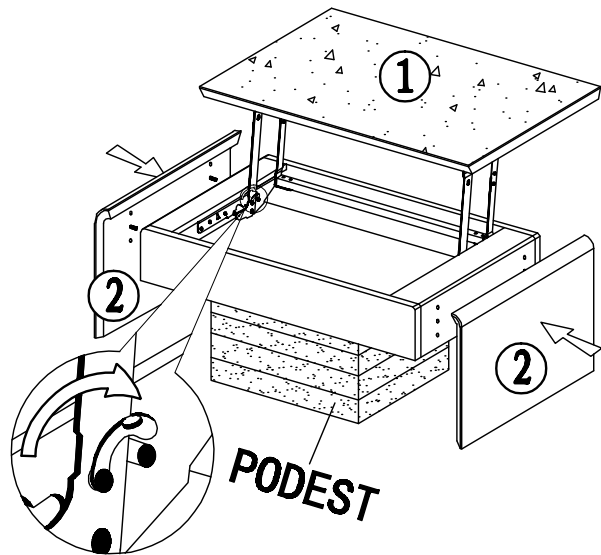

3

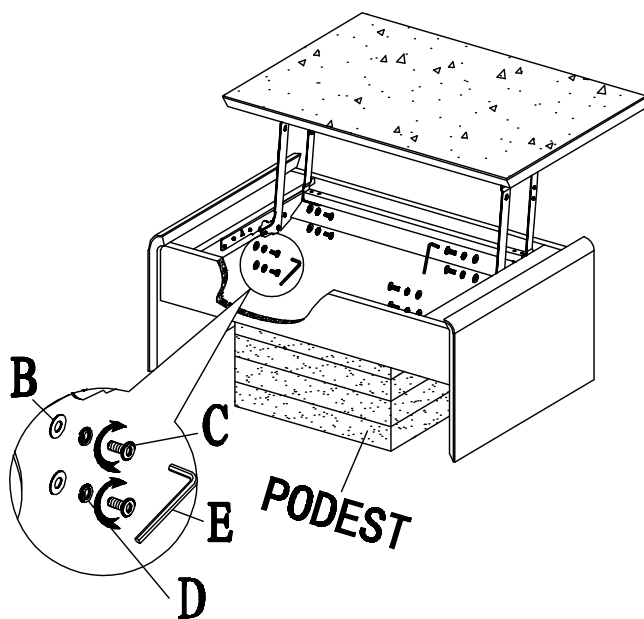

4

